

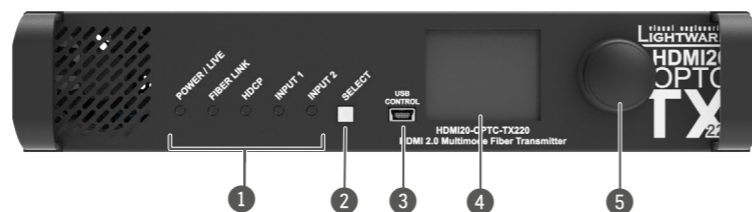

Quick Start Guide

HDMI20-OPTC-TX220-PRO, -RX220-PRO
HDMI20-OPTC-TX220-FOX, -RX220-FOX
HDMI20-OPTC-TX220-NTQ, -RX220-NTQ
HDMI20-OPTC-TX220-PCN, -RX220-PCN

Front View - HDMI20-OPTC-TX220-Pro



Front View - HDMI20-OPTC-RX220-Pro

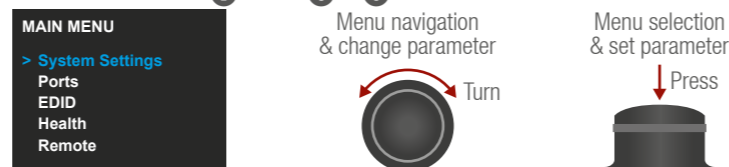
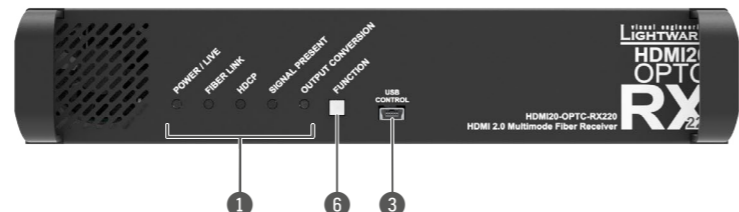

Front View Legend

- Status LEDs** The LEDs give feedback about the current status, connections and certain settings of the unit. For details, see the front panel's LEDs in the next section.
 - TX: Select button** The Select button toggles between Input 1 and Input 2.
 - TX: Function button** The Function button sets the output conversion mode. See the details below.
 - USB Port** USB mini-B port for controlling the unit locally by the Lightware Device Controller software.
 - TX: LCD display** Display of the front panel menu.
 - TX: Jog dial knob** Browse the menu by turning the knob, click on the desired item to check or change it.
- All models have the same look and controls on the front panel.**

LCD Menu and Navigation

The front panel has a color LCD showing the most important settings and parameters. The jog dial control knob can be used to navigate between the menu items or change the value of a parameter (both on the transmitter and the receiver). The knob can be pressed to enter a menu or edit/set a parameter.

Rear View - HDMI20-OPTC-TX220-Pro

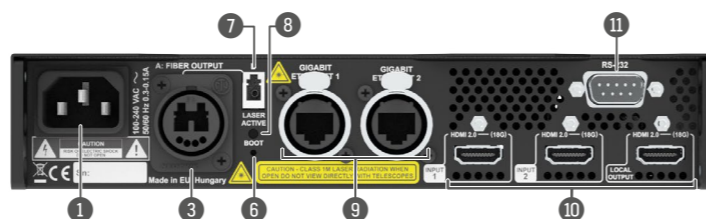

Rear View - HDMI20-OPTC-RX220-Pro

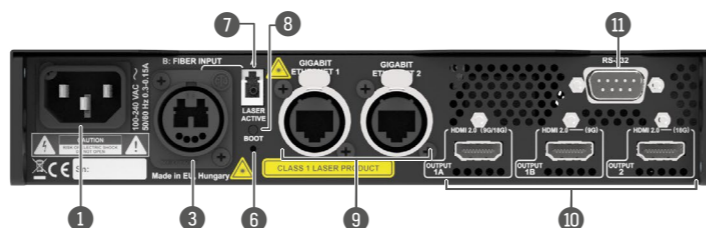

All models have the same functionality, the difference is only the connector types. See more details in the model comparison chart below.

- AC connector** Standard IEC or NT powerCON TRUE 1 connector accepting 100-240 V, 50 or 60 Hz.
- Fiber optical connector** Depending on the model type, the fiber optical connector is Neutrik opticalCON DUO / Fiberfox / Neutrik opticalCON QUAD. The **channel A** carries the signal from the transmitter to **channel B** in the receiver.
- Boot button** Hidden button for special bootload function.
- Break-out connector** The break-out LC connector is internally connected to the **channel B** of Neutrik connector in the transmitter and the **channel A** in the receiver. It is to carry any optical signal from the break-out LC connector.
- Laser LED** It gives feedback about the operation of the optical module. When the laser is active (laser LED is ON), it radiates invisible waves from the optical connector. Do not expose users of telescopic optics to the beam!
- LAN** Two Neutrik etherCON connectors for Gigabit Ethernet (to control the unit or for pass-through). Both are in the same local network. Remote powering (PoE) is not possible.
- TX: HDMI connector** Two HDMI 2.0 inputs and one HDMI 2.0 output port for local display.
- RX: HDMI connector** Three HDMI video output ports. Output signal depends on the output conversion setting, see the details below.
- Serial port** D-SUB connector for bi-directional RS-232 communication (control/command injection/pass-through mode).

Port Diagram - Video Concept

Transmitter Side

The video signal is received at **Input 1** or **Input 2**. The HDMI splitter duplicates the signal and sends the same HDMI stream to the local HDMI output and the fiber output.

Receiver Side

The video signal arrives via optical cable into the HDMI splitter. It duplicates the HDMI stream and transmits the signal without modifying it to the **HDMI Out 2** port. The HDMI splitter transmits the same signal into the video converter where three output conversion modes can be set. It specifies how to deal with the HDMI 2.0 signal and what would be the output video signal on the **Out 1A** and the **Out 1B**.

HDMI20-OPTC-TX220

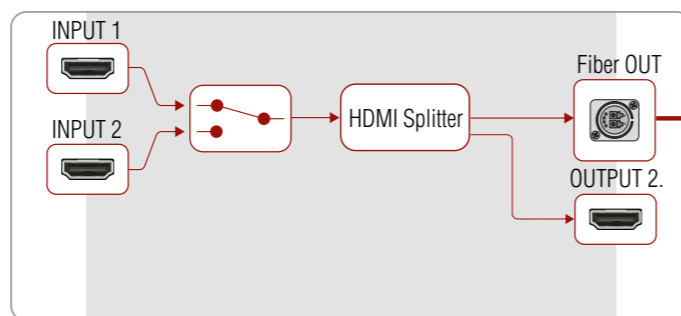

HDMI20-OPTC-RX220

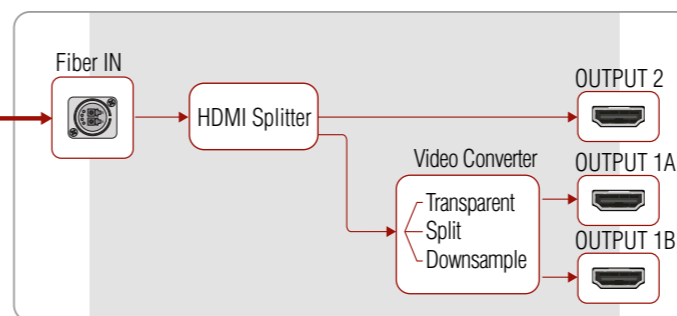

Rear Panel's LEDs

Laser active		Transmitter / Receiver
● on	It gives feedback about the operation of the optical module, that means the laser radiates invisible waves. Do not expose users of telescopic optics to the beam!	
○ off	Laser module is not active.	

Front Panel's LEDs

Power / LIVE		Transmitter / Receiver
● blinking	The transmitter unit is powered and ready to use.	
○ off	The transmitter unit is NOT powered or out of operation.	
Fiber link		Transmitter / Receiver
● on	The connection is established between the transmitter and the receiver and they can communicate to each other.	
○ off	When the TX and RX are not connected.	
● blinking	It shows connection error in the RX and TX.	
HDCP		Transmitter / Receiver
● on	Video signal is HDCP-encrypted.	
○ off	There is no HDCP encryption in the video signal.	
● blinking	It shows HDCP error.	

Input 1, Input 2		Transmitter
● on	This port is selected and there is a valid video signal on it.	
● blinking	When the port is selected and there is no valid video signal on it.	
● on	When the port is not selected, but there is a valid video signal on it.	
○ off	This port is not selected and there is no signal on it.	

Select button is for switching between Input 1 and Input 2.

Signal present		Receiver
● on	Valid video signal is present.	
○ off	No video signal is present.	
● blinking	It shows error in the video signal transmission.	
Output conversion		Receiver
● on	Split mode is active.	
○ off	Transparent mode (no conversion) is active.	
● on	Downsample convert mode (convert to YCbCr 4:2:0) is active.	

Important Safety Instructions

Please read and keep the information in the attached safety instructions supplied with the product before you start using the device.

Receiver (RX): Class 1 laser product.

Transmitter (TX): Laser radiation! Do not expose users of telescopic optics! Class 1M laser radiation.

Introduction

Thank you for choosing Lightware HDMI2.0-OPTC series devices. The HDMI2.0-OPTC series extenders are HDMI 2.0 compatible extender pair for video, embedded audio, RS-232 and Gigabit Ethernet signals, supporting uncompressed 4K UHD resolution at 60Hz 4:4:4. This extender pair is particularly recommended for rental and staging applications, 4K live events, and for future-proof operation centers. According to the philosophy of Lightware's optical extenders, the transmitter and the receiver operate in pairs, so the transmitter is designed with LCD screen and jog dial control knob. This is for controlling the transmitter itself but it also controls and is able to configure the receiver.

Box Contents

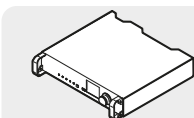

Transmitter / Receiver unit



Safety and Warranty Info, Quick Start Guide

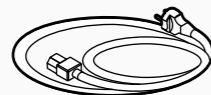

IEC power connector¹



Power cable with Neutrik powerCON connector²

¹ For HDMI20-OPTC-TX220-PRO, -RX220-PRO, HDMI20-OPTC-TX220-FOX, -RX220-FOX, HDMI20-OPTC-TX220-NTQ, -RX220-NTQ models.

² For HDMI20-OPTC-TX220-PCN, -RX220-PCN models.

Model Comparison

Model suffix	Optical connector	Power connector
-PRO	Neutrik opticalCON DUO	Standard IEC (C14 type)
-FOX	Fiberfox	Standard IEC (C14 type)
-NTQ	Neutrik opticalCON QUAD	Standard IEC (C14 type)
-PCN	Neutrik opticalCON DUO	Neutrik powerCON TRUE 1

All models have the same functionality, the difference is only the connector types.

Further information on this device is available on www.lightware.com.

The User's Manual is also available via the QR code below:



Contact us

sales@lightware.com

+36 1 255 3800

support@lightware.com

+36 1 255 3810

Lightware Visual Engineering PLC.

Budapest, Hungary

Doc. ver.: 1.4

19210019

Connecting Steps

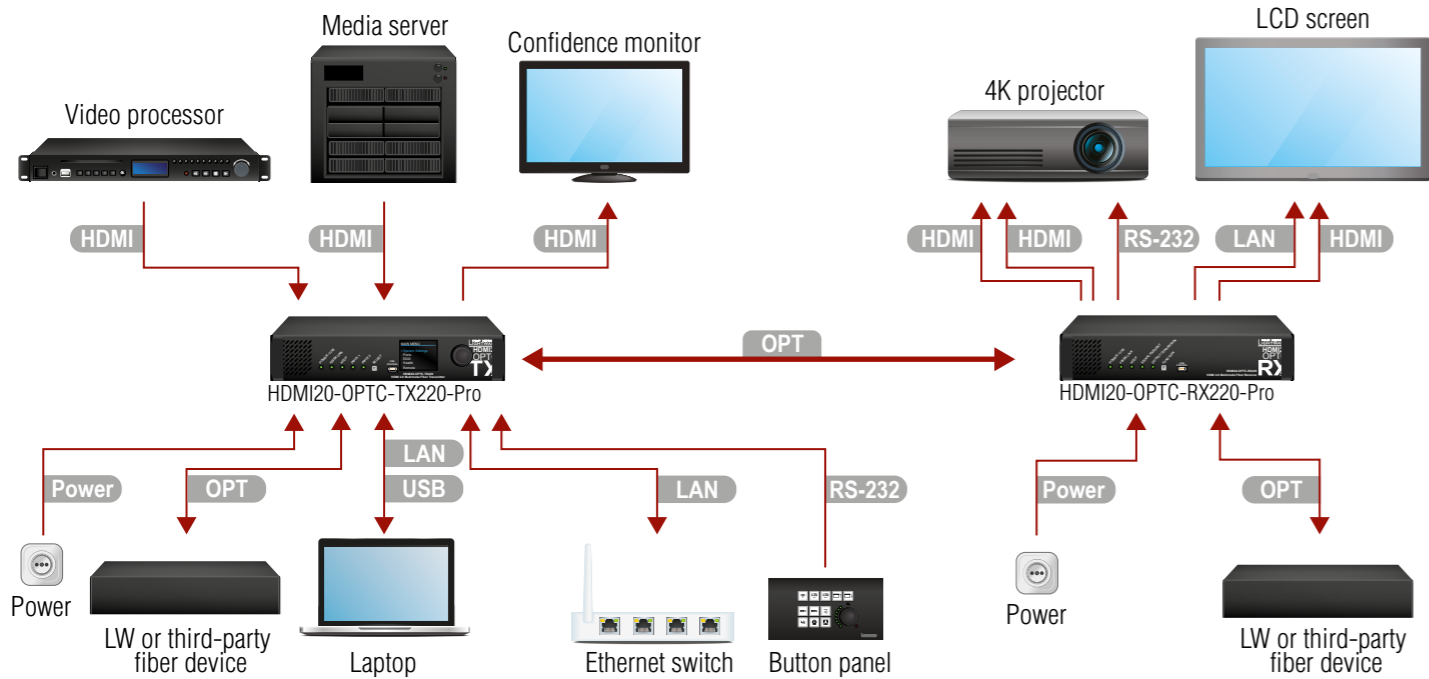

- OPT** Connect a multimode (MM) fiber cable to channel A of the transmitter.
- OPT** Optionally connect a compatible Lightware device or a third-party device to the break-out LC connector. It is internally linked to channel B of the Neutrik connector.
- HDMI** Connect an HDMI source (e.g. video processor or media server) to any of the inputs of the transmitter.
- HDMI** Optionally connect an HDMI sink (e.g. confidence monitor) to the HDMI output of the transmitter. The displayed signal of the output port is equal with the extended video signal.
- LAN** Optionally connect Ethernet devices (e.g. switch, laptop, computer etc.) to the available Neutrik etherCON connector(s) of the extender(s). All connected devices will work as if they are connected to the same network.
- USB** Optionally connect a USB mini-B type cable between the transmitter unit and the computer in order to control the device.
- RS-232** Optionally for RS-232 extension: connect a controller unit (e.g. button panel) to the RS-232 port of the transmitter with a null modem serial cable.
- Power** Connect the power cord to the AC power socket to the transmitter unit. It is recommended to power on the devices as the final step.

- OPT** Connect a multimode (MM) fiber cable to channel B of the receiver.
 - OPT** Optionally connect a compatible Lightware device or a third-party device to the break-out LC connector. It is internally linked to channel A of the Neutrik connector.
 - HDMI** Connect an HDMI sink (e.g. 4K projector) to the HDMI 1A and the 1B output ports and an other sink (e.g. LCD screen) to the HDMI 2 output port.
 - LAN** In order to control, optionally connect Ethernet devices (e.g. 4K LCD screen) to the available Neutrik etherCON connector of the extender.
 - RS-232** Optionally for RS-232 extension: connect a controlled device (e.g. Projector) to RS-232 port of the receiver with a serial cable.
 - Power** Connect the power cord to the AC power socket to the receiver unit. It is recommended to power on the devices as the final step.
- ⚠ Connecting the transmitter and receiver to the same LAN while they are connected to each other via fiber is not recommended. In case of an Ethernet loop the extenders are not available via LAN.

Application of Brake-Out Connector

Neutrik OpticalCON connector has two fiber channels. Lightware fiber extenders use only one fiber for signal transmission and the other fiber is available through the break-out connector. In this case, one Neutrik OpticalCON Duo cable is enough to transmit two different AV signal from one transmitter pair to another receiver pair.

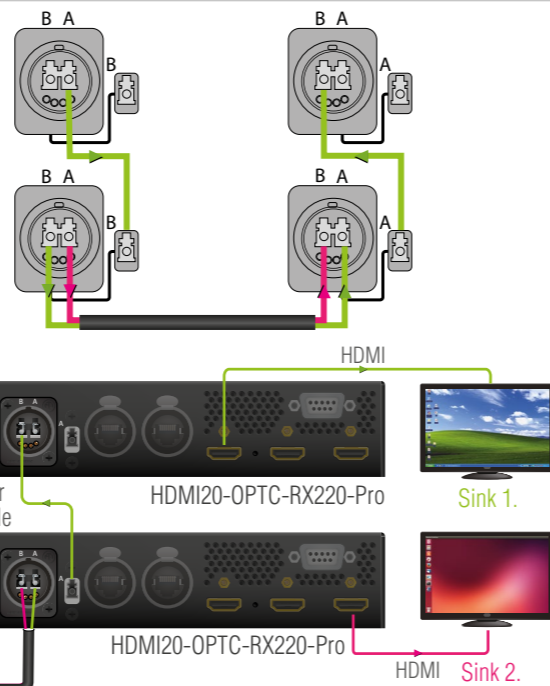
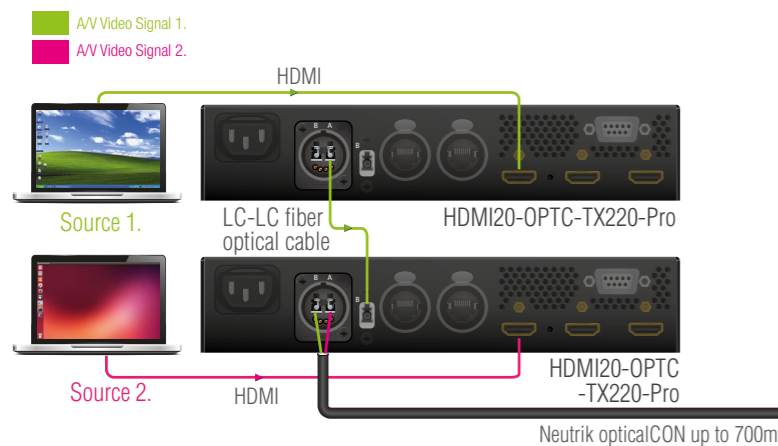

Neutrik opticalCON up to 700m

Mounting as a Standard Rack Installation (HDMI20-OPTC-TX220)

- Two mounting holes on the front ears and two on the back of the chassis is for fastening two units to each other with 2x 2pcs M4x8 mm screws. This way you get a one-rack wide and 1U high device.
 - Fix the rack ears on the left and right side as shown in the picture. The default position allows mounting the device as a standard rack unit.
- To order the rack mounting kit, please contact sales@lightware.com.

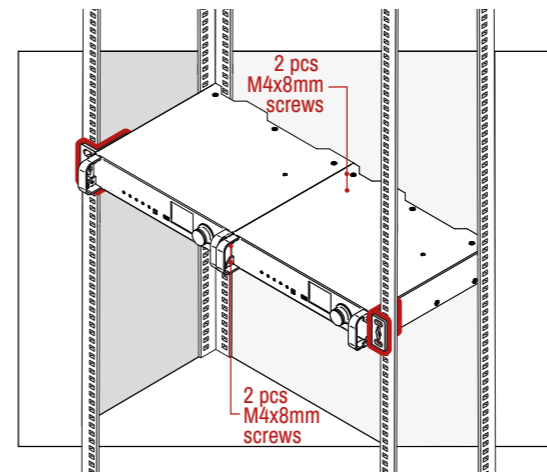

Truss Mounting (HDMI20-OPTC-RX220)

- Mounting thread on top and on one of the sides is for safe and secure installation. Rigging the handles with a safety wire rope is highly recommended for safety reasons. (Truss mounting clamp and safety wire rope are not available at sales.)
- ⚠ Using different (e.g. longer) screws may cause damage to the device.
 - ⚠ Pay attention to the ventilation holes when designing the system or the extender is built into furniture. Side ventilation holes must not be covered.

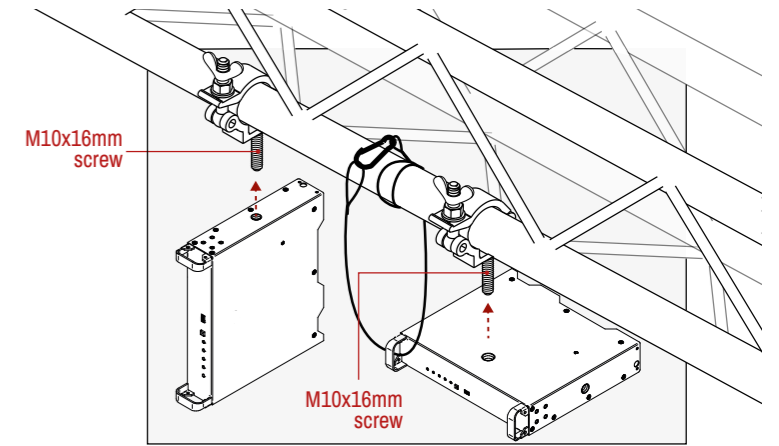

Typical Application

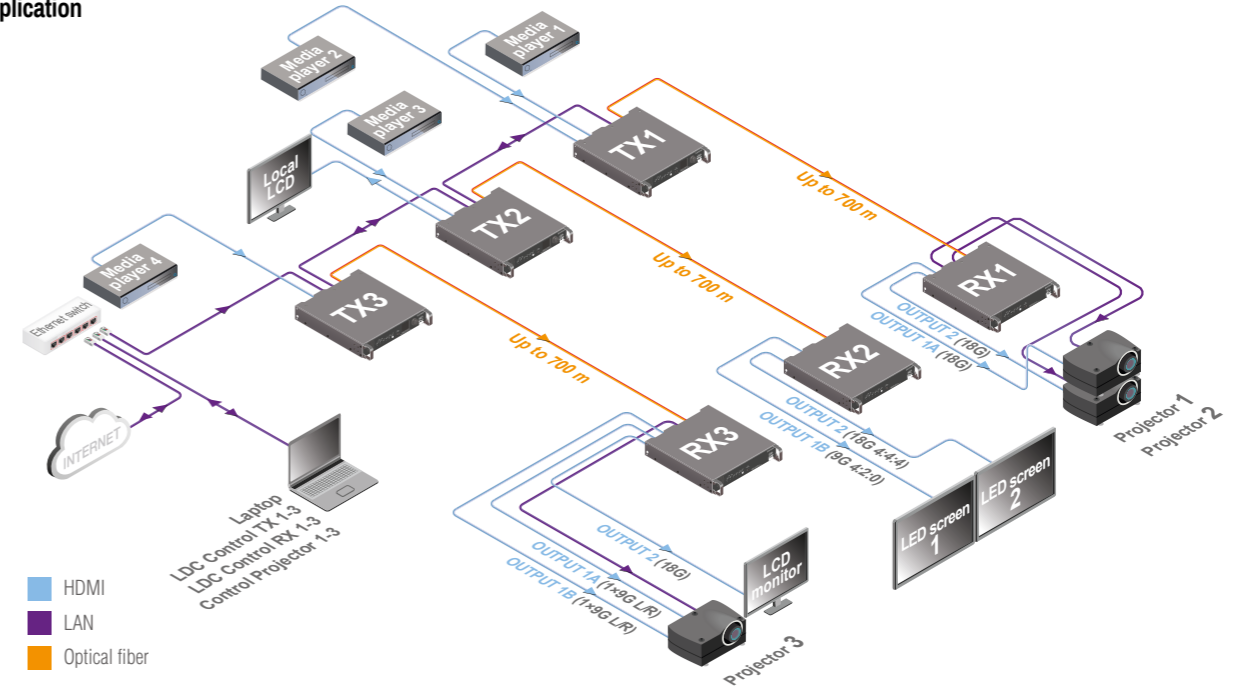

Typical Application Description

The two Ethernet connectors on each extender make it possible to daisy chain the devices and build a local network where all the transmitters (1..3) and receivers (1..3) are available via LAN. They can be controlled by the Lightware Device Controller (LDC) software from the laptop. Optical fiber cable transmits the HDMI, embedded audio, Ethernet, and RS-232 signal to the receivers, so in this case, the sinks can be controlled by Ethernet commands from the control device (laptop).

In this example, all the sources send HDMI 2.0 4K@60Hz 4:4:4 A/V signal to the transmitters, which extend the stream to the receivers via multimode fiber cable.

Receiver 1..3 represent three applications of the output modes:

- RX1 is in **transparent mode** (no conversion mode), the sinks are stacked projectors. The video signal is HDMI 2.0 4K@60Hz 4:4:4 on the Output 1A and the Output 2 ports.
- RX2 is in **downsample convert mode** (convert to YCbCr 4:2:0). The LED screen 2 is 4K compatible and connected to the Output 2 port. LED screen 1 is not HDMI 2.0 4K@60Hz 4:4:4 compliant, so the video processor in the receiver converts the HDMI signal from 4:4:4 to 4:2:0, and this way the sink will be able to accept the signal on Output 1B.
- RX3 is in **split mode**. The receiver supports vertical splitting of the HDMI 2.0 4K@60Hz 4:4:4 input signal to left and right halves allowing for the transmission of an 18Gbps HDMI 2.0 signal over two HDMI1.4 compliant links. The sink is a projector, which is able to recombine the two half signals. Video signal is transmitted to Output 2 without any changing.

Software Control – Using Lightware Device Controller (LDC)

The device can be controlled from a computer using the Lightware Device Controller software. The application is available at www.lightware.com, install it on a Windows PC or a macOS and connect to the device via LAN, USB, or RS-232.

Firmware Update

Lightware Device Updater2 (LDU2) is an easy and comfortable way to keep your device up-to-date. Establish the connection via Ethernet. Download and install LDU2 software from the company's website www.lightware.com, where you can find the latest firmware package as well.

Factory Default Settings

IP address - Transmitter (static)	192.168.0.101
IP address - Receiver (static)	192.168.0.102
Subnet mask / Static gateway	255.255.255.0 / 192.168.0.1
DHCP	Disabled
TCP/IP port nr. LW3	6107
RS-232 port setting	57600 BAUD, 8, N, 1
Crosspoint setting	input 1 on all outputs
HDCP enabled I1 / I2	Allow HDCP 1.4 or 2.2 / Allow HDCP 1.4
HDCP mode (TX / RX)	Auto / Depends on Input
Emulated EDID	D1